

Premium Preparation 1600 mm Meat & Fish Processing/ Washing Table

ITEM # _____

MODEL # _____

NAME # _____

SIS # _____

AIA # _____

132963 (TLC1600EN)

 Meat and Fish Processing/
Washing Table with
perforated and removable
Plates, knife holder,
polythene cutting board,
drain, scraping hole and
upstand, 1600mm

Short Form Specification

Item No. _____

50mm high worktop in 304 AISI stainless steel, 1,5mm in thickness, sound-deadened, anti-drip edges and welded corners. Integral radiused rear upstand, h=100mm with 10mm radius. All-round apron. Round section legs and feet in 304 AISI stainless steel, 50mm in diameter. N.1 polythene cutting board 1130x225x25h mm, drain and waste scraping hole on front.

Main Features

- Sturdiness, stability and reliability of table accurately tested.

Construction

- Table can be equipped with a mobile bin with lid for waste disposal (optional accessory).
- Round section legs with feet in 304 AISI stainless steel, 50 mm in diameter, adjustable in height by +0/-40 mm.
- Unit features a 20 mm deep recessed surface, a polythene cutting board and a scraping hole on the front, perforated and sectionated removable tops, an easily removable GN liquid container and a knife holder. Knife sanitizer can be supplied as optional.

Optional Accessories

- Lower shelf for 1600mm for units PNC 855284
- Set of 4 wheels (2 with brake) d. 100mm PNC 855288
- 3-sided underframe for 1600mm tables PNC 855292
- Elbow operated mixer tap with spout 3/4", single hole PNC 855322
- Elbow operated mixer tap with short spout 3/4", single hole PNC 855323
- Foot operated mixer tap (hot and cold) with spout 3/4" PNC 855328
- Floor fastening kit for 2 square legs PNC 865386

Recommended Detergents

- S01 STAINLESS STEEL SURFACE POLISHER; 6 BOTTLES X 750ML C/T PNC 0S2881
- S03 ALCOHOL BASE DETERGENT; 6 BOTTLES X 750ML; ADR&IMDG&IATA Limited Quantity PNC 0S2883
- S04 GLASSES & HARD SURFACES CLEANERS; 6 BOTTLES X 750ML PNC 0S2884
- S05 - MULTIPURPOSE DEGREASER; 6PCS X 750ML; ADR&IMDG Limited Quantity PNC 0S3257

APPROVAL: _____

Front

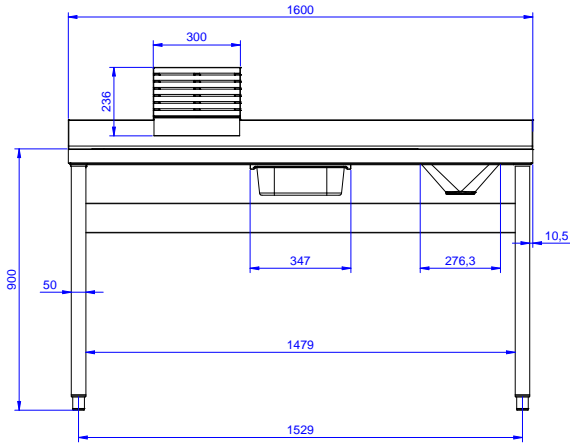

Side

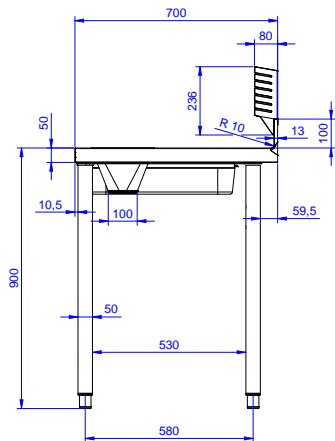

D = Drain

Top

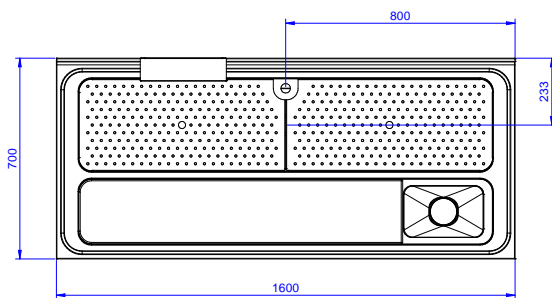



Electrolux
PROFESSIONAL

Premium Preparation 1600 mm Meat & Fish Processing/ Washing Table

Key Information:

External dimensions,
Width:

132963 (TLC1600EN) 1600 mm

External dimensions,
Depth:

700 mm

External dimensions,
Height:

1000 mm

Upstand Dimensions,
Height:

100 mm

Upstand Dimensions,
Depth:

13 mm

Upstand Dimensions,
Radius:

R=10

Bowls number

1

Bowl dimensions

1670x320xH180

Worktop thickness:

50 mm

Net weight:

60 kg



Premium Preparation
1600 mm Meat & Fish Processing/Washing Table

The company reserves the right to make modifications to the products
without prior notice. All information correct at time of printing.

2026.05.23